

Query Order

Step ramps without railings

Please fill in and send by Fax to 0421/24105-15 or to info@rollstuhlrampen.de

Name

Street, House No.

Postcode, City, Country

Telephone / Fax

Contact

E-mail

Commission

Variant 1:
Only with support (without props)

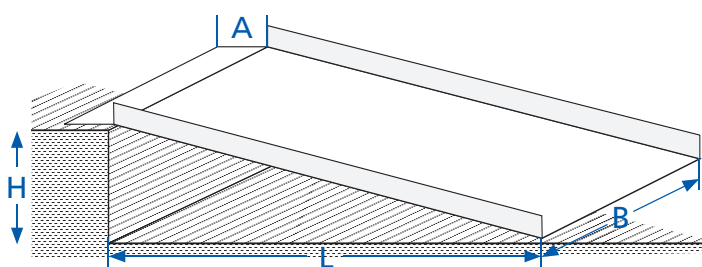

Variant 2:
Without support, with props

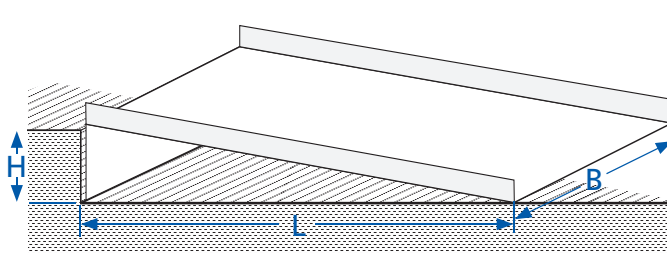

Variant 3:
With support and props

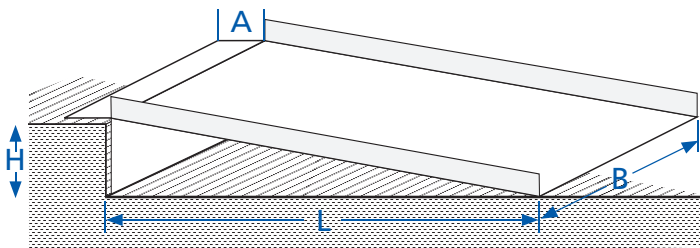

"Alternative" with step section:
With support and props

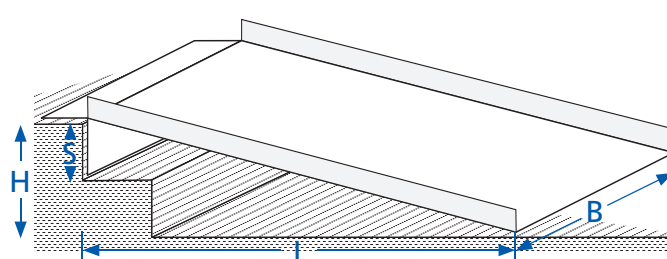

H: _____ cm A: _____ cm

L: _____ cm S: _____ cm

B: _____ cm

Max . load up to 250 kg!

- E-wheelchair
- Self-operator without E- drive
- Is pushed

Pushing person:

- Light Heavy

Weight rollator + person: _____ kg

Carry handle Yes No (if "Yes", mark the position
Where it is to be mounted)

Note: For production reasons, railings cannot be installed in this ramp type.

Is your step situation missing? Please draw your own sketch:



Query Order
Step ramps without wheel guide curbs

Fill in and send by Fax to 0421/24105-15 or to info@rollstuhlrampen.de



_____ Name

_____ Street, House No.

_____ Postcode, City, Country

_____ Telephone / Fax

_____ Contact

_____ E-mail

_____ Commission

Variant 4:
without support

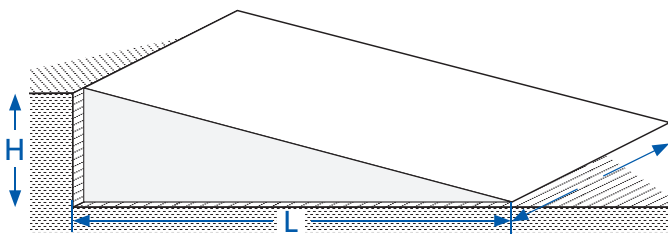

"Alternative" with step section:
without support / for several steps

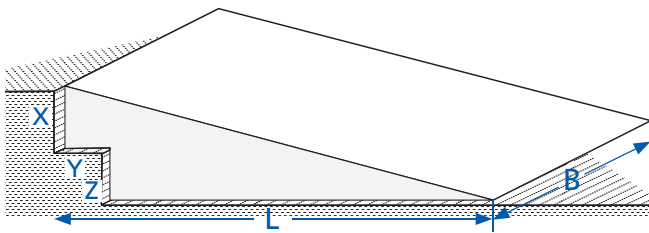

Variant 5:
with support

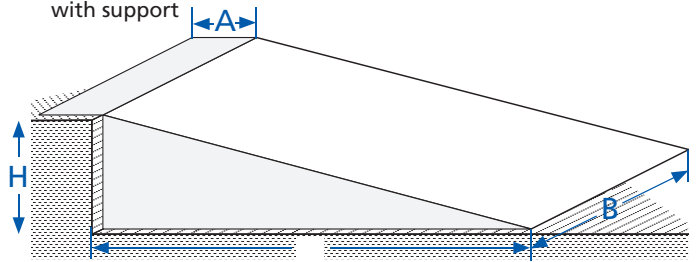

"Alternative" with step section:
with support / for several steps

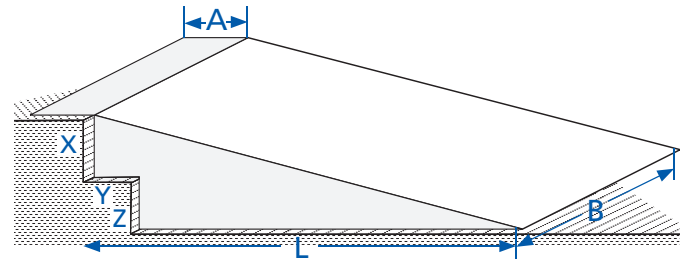

H: _____ cm X: _____ cm
 L: _____ cm Y: _____ cm
 B: _____ cm Z: _____ cm
 A: _____ cm (10cm length)

Max . load up to 250 kg!

- E-wheelchair
- Self-operator without e-drive
- Is pushed

Pushing person:

- Light Heavy

Weight of wheelchair + Person: _____ kg

Carry handle Yes No (if "Yes", mark the position
 Where it is to be mounted)

Note: For production reasons, railings cannot be installed in this ramp type.

Is your step situation missing? Please draw your own sketch:

Query Order

Platforms for step ramps

Fill in and send by Fax to 0421/24105-15 or to info@rollstuhlrampen.de



please copy

Name

Street, House No.

Contact

Postcode, City, Country

E-mail

Telephone / Fax

Commission

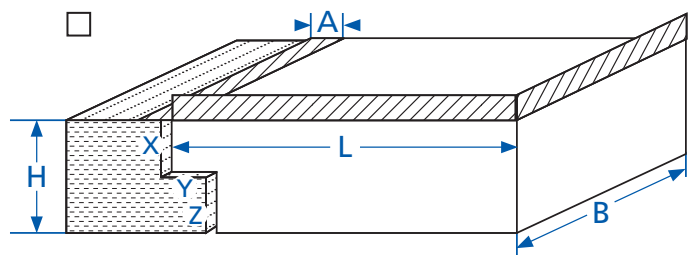
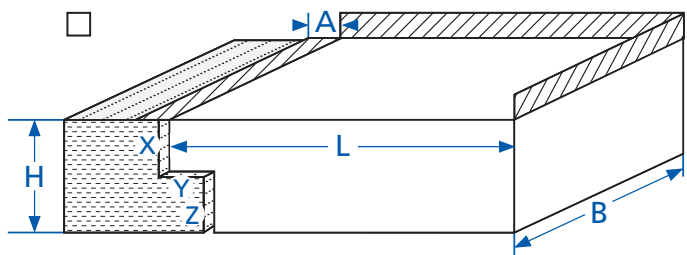
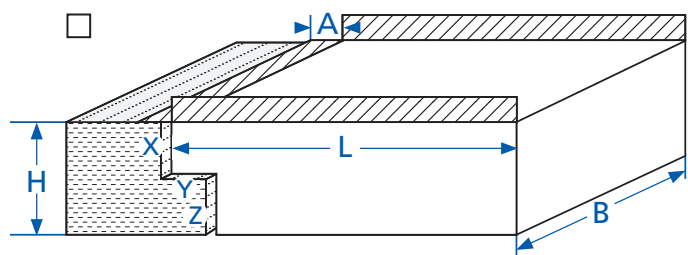
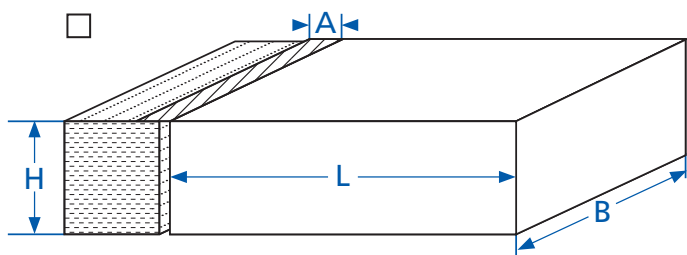

Load up to 250 kg!

- L: _____ cm H: _____ cm
- B: _____ cm X: _____ cm
- A: _____ cm Y: _____ cm
- without support Z: _____ cm
- with support

Recommended/optional

- Straight passage 100 x 100 cm
- Passage over corner 120 x 120 cm
- Support 10 cm

All platforms can be adjusted in height by +/- 2cm.

Please also observe the examples on the reverse side!

Is your step situation missing? Please draw your own sketch here:



Examples Platforms for step ramps

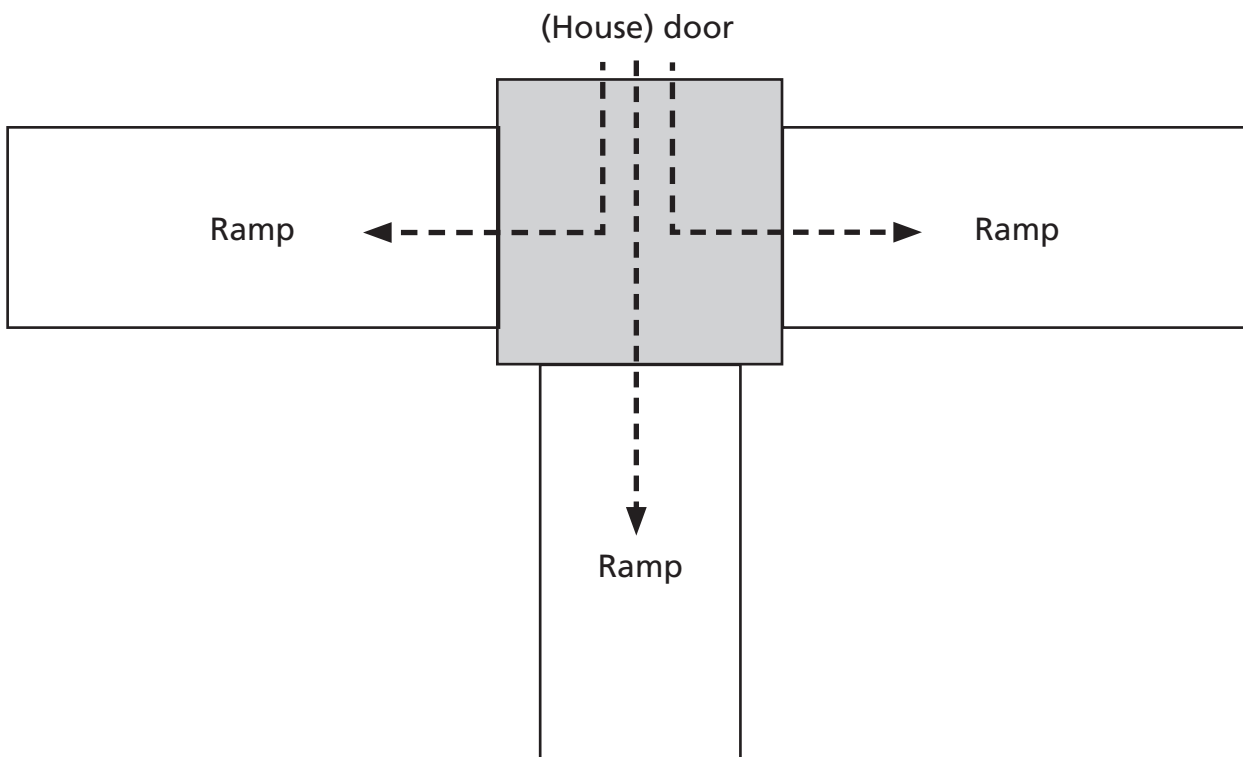
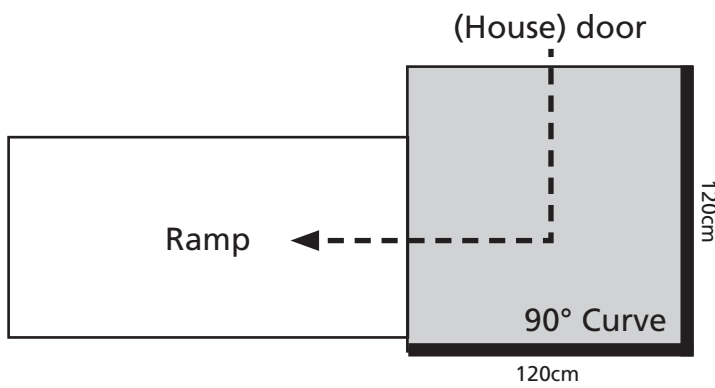
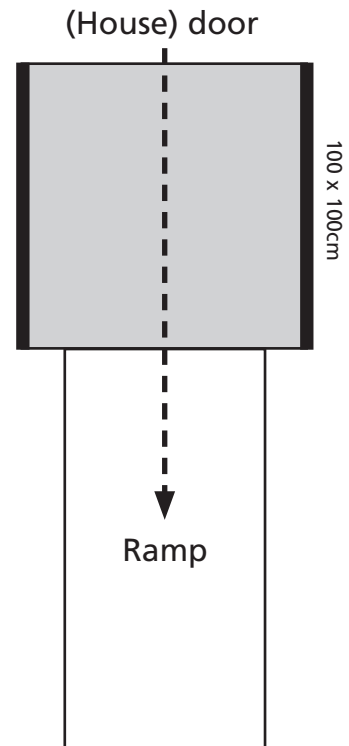
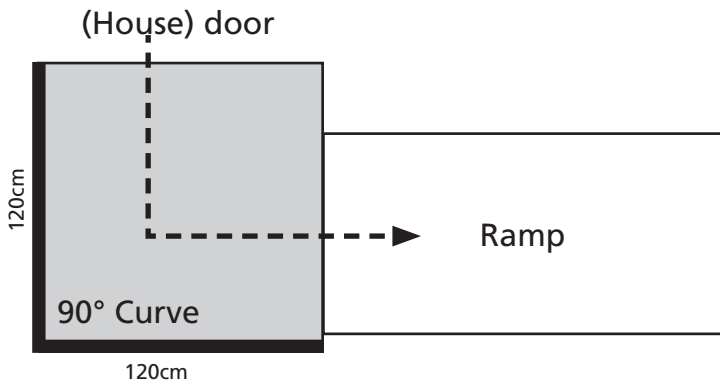

Query Order

Door sill ramps, single-section

Fill in and send by fax to 0421/24105-15 or to info@rollstuhlrampen.de



please copy

Name

Street, House No.

Postcode, City, Country

Telephone / Fax

Contact

E-mail

Commission

Without wheel guide curbs

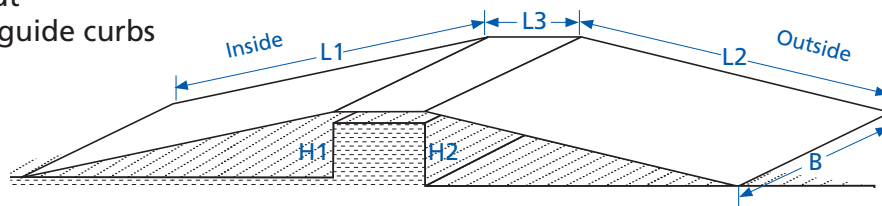

With wheel guide curbs

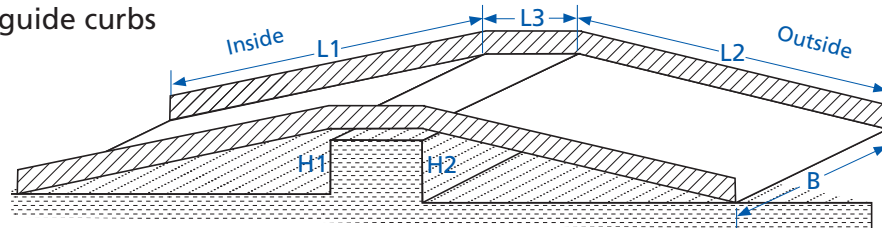

H1: _____ cm

H2: _____ cm

L1: _____ cm

L2: _____ cm

L3: _____ cm

B: _____ cm

Note:

Not suitable for balcony doors!

If the ramps must be removed for closing the door, please use the form "Terrace door ramps", as this ramp type is essentially easier to handle

Carry handle Yes No

If "Yes", please mark the position at which it is to be mounted)

Is your step situation missing? Please draw your own sketch here:

E-wheelchair

Self-operator without e-drive

Is pushed

Pushing person:

Light Heavy

Weight wheelchair + person: _____ kg



Query Order
Terrace door ramps

Fill in and send by fax to 0421/24105-15 or to info@rollstuhlrampen.de

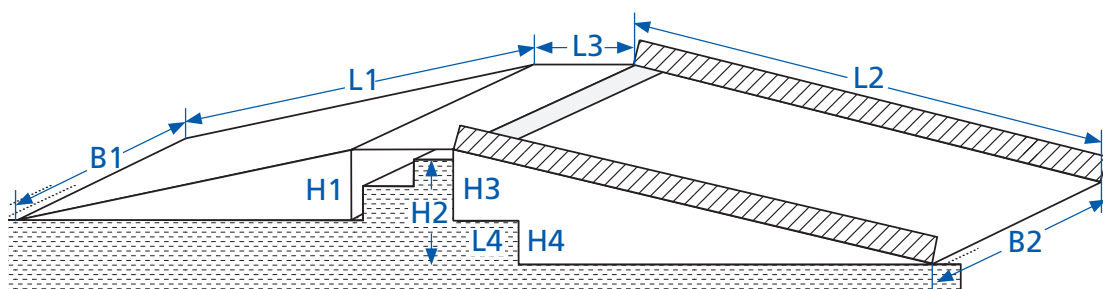
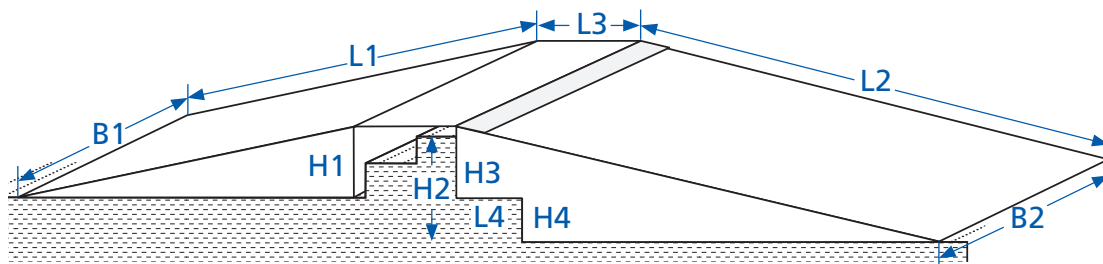

H1: _____ cm

B1: _____ cm

L1: _____ cm

H2: _____ cm

B2: _____ cm

L2: _____ cm

H3: _____ cm

L3: _____ cm

H4: _____ cm

L4: _____ cm

Is your step situation missing? Please draw your own sketch here:

Query Order
Terrace door ramps, 2-section

Fill in and send by fax to 0421/24105-15 or to info@rollstuhlrampen.de

Name _____

Street, House No. _____

Postcode, City, Country _____

Telephone / Fax _____

Contact _____

E-mail _____

Commission _____

zTSR-Au without wheel guide curbs

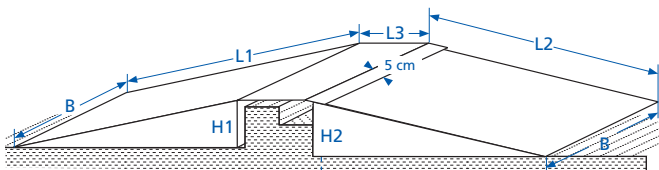

Inside:
Remove to shut door

Outside:
Stays!

H1: _____ cm H2: _____ cm
 L1: _____ cm L2: _____ cm
 L3: _____ cm B: _____ cm

zTSR-Ao with wheel guide curbs

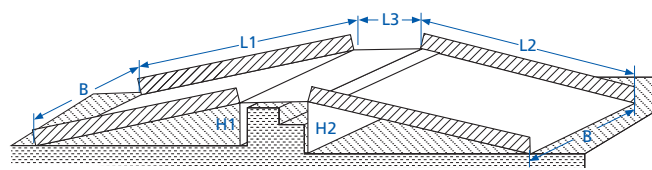

Inside:
Remove to shut door

Outside:
Stays!

H1: _____ cm H2: _____ cm
 L1: _____ cm L2: _____ cm
 L3: _____ cm B: _____ cm

zTSR-Au without wheel guide curbs with stepsection

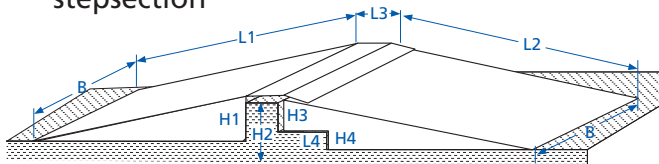

Inside:
Remove to shut door

Outside:
Stays!

H1: _____ cm H2: _____ cm
 L1: _____ cm H3: _____ cm
 L2: _____ cm H4: _____ cm
 L3: _____ cm L4: _____ cm
 B: _____ cm

zTSR-Ao with wheel guide curbs for several steps

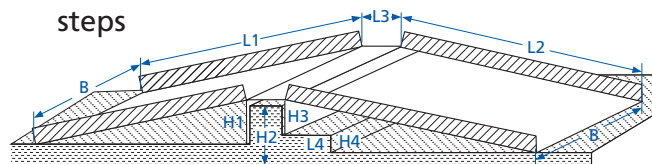

Inside:
Remove to shut door

Outside:
Stays!

H1: _____ cm H2: _____ cm
 L1: _____ cm H3: _____ cm
 L2: _____ cm H4: _____ cm
 L3: _____ cm L4: _____ cm
 B: _____ cm

Max . load up to 250 kg!

- E-wheelchair
 Self-operator without e-drive
 Is pushed
 Pushing person:
 Light Heavy
Weight wheelchair + person: _____ kg

Carry handle Yes No (If "Yes", please mark the position where it is to be mounted)

- Door opens inside
 Door opens outside
 Sliding door

Is your step situation missing? Please draw your own sketch and add it.

Query Order

Terrace door ramps, 3-section

Fill in and send by fax to 0421/24105-15 or to info@rollstuhlrampen.de



- Ramps should always remain laid.
- Door opens and shuts over ramp.
- Only one bridging ramp to be removed to shut door!

View: Door closed

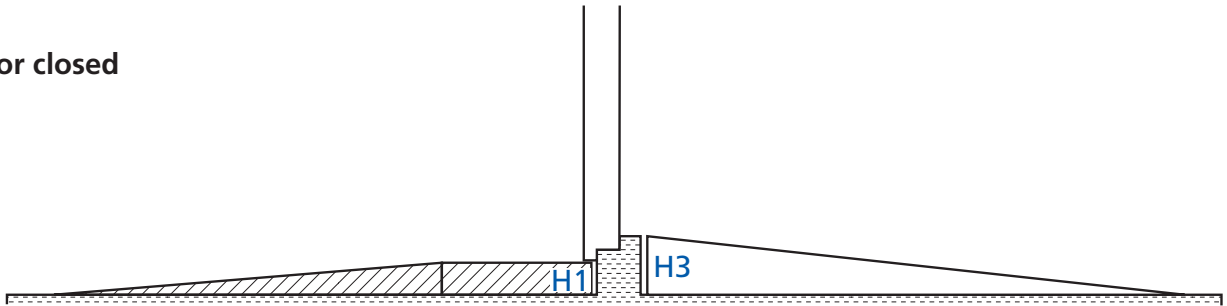

View: Door open

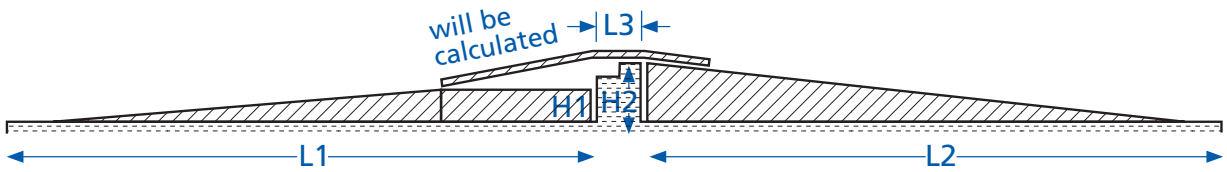

H1 = Height below the shut door: _____

L1 = Inside length: _____

H2 = Full height of door frame: _____

L2 = Outside length: _____

H3 = Outside height _____

L3 = Depth of door frame: _____

Carry handle Yes No

Max. ramp width _____ cm

If "Yes", please mark the position at which it is to be mounted)

Door opens inside

Door opens outside

Sliding door

Is your step situation missing? Please draw your own sketch here:

Query Order
Telescopic ramps & rail ramps

Fill in and send by fax to 0421/24105-15 or to info@rollstuhlrampen.de



please copy

Name

Street, House No.

Postcode, City, Country

Telephone / Fax

Contact

E-mail

Commission

Art. No.	Ramp length ¹	Ramp width	Track width	Weight	Load	Query	Order
2-section models:							
TR130	80-137 cm	25 cm	19 cm	9 kg /pair	250 kg /pair	<input type="checkbox"/>	<input type="checkbox"/>
TR195	110-198 cm	25 cm	19 cm	13 kg /pair	250 kg /pair	<input type="checkbox"/>	<input type="checkbox"/>
TR310	170-317 cm	25 cm	19 cm	22 kg /pair	200 kg /pair	<input type="checkbox"/>	<input type="checkbox"/>
3-section models:							
TR290	113-287 cm	26 cm	18 cm	23 kg /pair	200 kg /pair	<input type="checkbox"/>	<input type="checkbox"/>

¹ Total length incl. support • Support length: 10 cm • Lateral height: 4.5-6 cm

Art. No.	Ramp length ¹	Ramp width	Track width	Weight	Load	Query	Order
2-section models:							
LTR204	120-204 cm	24 cm	19 cm	13 kg /pair	320 kg /pair	<input type="checkbox"/>	<input type="checkbox"/>
3-section models:							
LTR290	120-290 cm	24 cm	17 cm	19 kg /pair	260 kg /pair	<input type="checkbox"/>	<input type="checkbox"/>

¹ Total length incl. support • Support length: 6 cm • Lateral height: 6 cm

Art. No.	Ramp length ¹	Support length	Ramp width	Weight	Load	Query	Order
Ascent ramps:							
AFR100	100 cm	10 cm	20 cm	4,5 kg /pair	250 kg / pair	<input type="checkbox"/>	<input type="checkbox"/>
AFR150	150 cm	10 cm	20 cm	6,5 kg /pair	250 kg / pair	<input type="checkbox"/>	<input type="checkbox"/>
AFR200	200 cm	10 cm	20 cm	8,5 kg /pair	250 kg / pair	<input type="checkbox"/>	<input type="checkbox"/>

¹ Total length including support

Is your ramp missing? Please draw your own sketch here:



Query Order
Section ramps

Fill in and send by fax to 0421/24105-15 or to info@rollstuhlrampen.de



Name

Street, House No.

Postcode, City, Country

Telephone / Fax

Contact

E-mail

Commission

Railings available as option

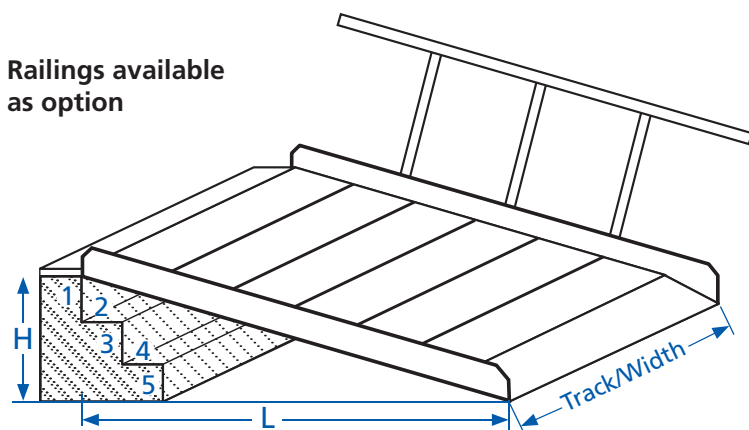

Please, dimension the stairs!
 From 4m length, in two pieces for the transportation

Track / Width:

- 80 / 88 cm
- 100 / 108 cm
- 120 / 128 cm
- _____ / _____ cm

Railings:

- without Railing**
- both sides
- on one side, in moving direction top left
- on one side, in moving direction top right

- E-wheelchair**
- Self-operator without e-drive**
- Is pushed**

Pushing person:

- Light Heavy

Weight wheelchair + person: _____ kg

Max . load up to 400 kg!

L: _____ cm

H: _____ cm

1: _____ cm

2: _____ cm

3: _____ cm

4: _____ cm

5: _____ cm

Is your step situation missing? Please draw your own sketch here:

Query Order

Platforms for section ramps

Fill in and send by fax to 0421/24105-15 or to info@rollstuhlrampen.de

Name

Street, House No.

Postcode, City, Country

Telephone / Fax

Contact

E-mail

Commission

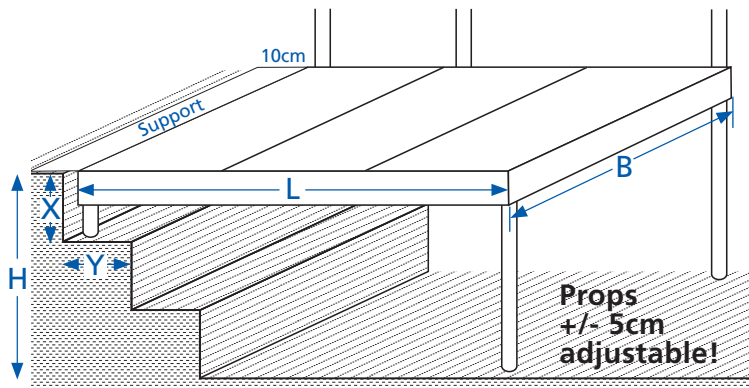

Load up to 400 kg

Additional steps on platform:

The number of steps is based on the total height, see examples X on the reverse side.

Without railings, but with overrun protection

Railings: left and right

Railings over corner

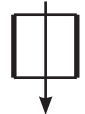
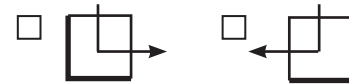

Please also see the examples and instructions on the reverse side!

Length

- 88 cm
- 128 cm
- 168 cm
- 208 cm

Width

- 100 cm
- 120 cm
- 150 cm
- _____ cm

H: _____ cm

X: _____ cm

Y: _____ cm

10 cm support for existing step

without support

*Is your step situation missing? Please draw your own sketch here:
(Please also see the examples on the reverse side)*



Examples Platforms for section ramps

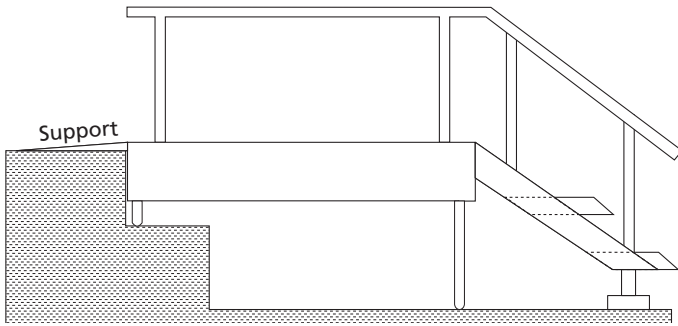

Example:

Platform with railings and steps

The number of steps is based on the total height!

